

Kitchen/Bathroom Tap Installation Instruction (Without Cover Plate)

Compatible Model: DT03M

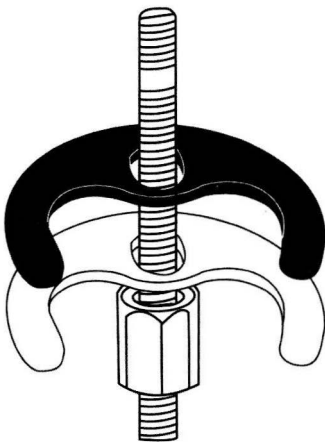





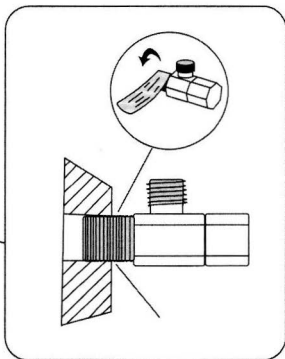
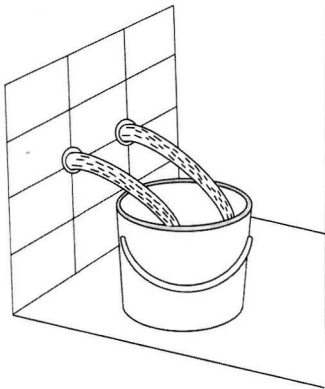

Before you begin

1. Shut off water supply.
2. Carefully inspect waste and supply tubing for signs of damage.
3. Replace waste or supply tubing if necessary.
4. Please rinse the pipe system before & after the installation.



Contact E-mail: faucet-world@hotmail.com

Installation Instruction(Without Cover Plate)

PIC	Components	QTY	PIC	Components	QTY
	A: Kitchen/Basin Tap	1		E: Threaded rod	1
	B: Rubber o-ring	1		F: Locking nuts	1
	C: Rubber c-shaped washer	1		G: Flexi hoses	2
	D: Metal c-shaped washer	1			

Step 1

Put **Rubber O-Ring (B)** into the **Tap (A)**.

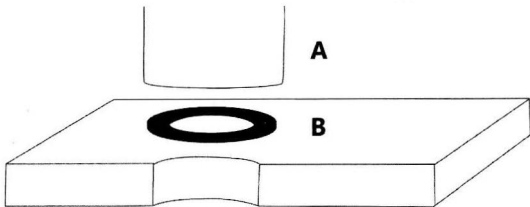

Step 2

Insert **Flexi Hoses (G)** from underneath & connect with the **Tap (A)**.

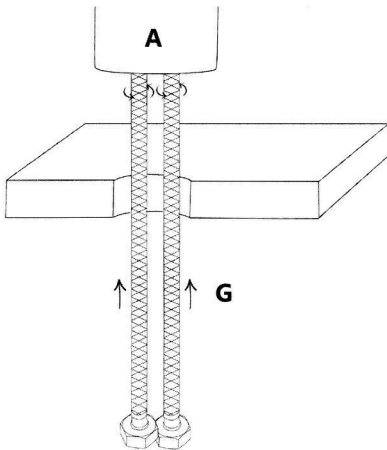

Step 3

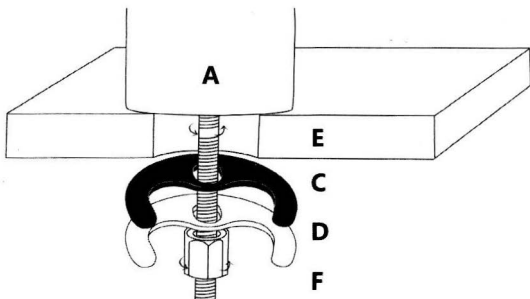

Get **Threaded Rod (E)** into **Metal C-Shaped Washer (D)** & **Rubber C-Shaped Washer (C)** in sequence, screw into the **Tap (A)**.



Step 4

Tighten the **Locking Nuts (F)**.

NOTICE:

Some Taps come with a Tool  for tightening the Locking Nuts, if not, we suggest you tighten the Locking Nuts with a Spanner  (Not Provided).

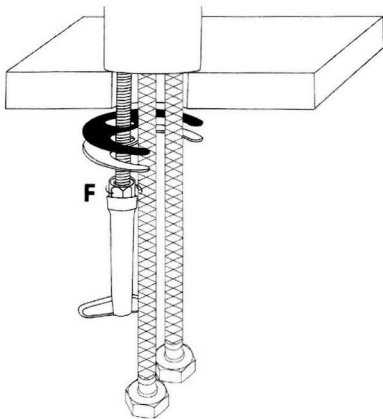

From: Amazon.co.uk <auto-confirm@amazon.co.uk>
Sent: 08 March 2025 15:52
To: gail-jones@virginmedia.com
Subject: Ordered: 'Kitchen Sink Mixer Tap...'

[Your Orders](#) [Your Account](#) [Buy Again](#)

Thanks for your order, SJJ!



Arriving tomorrow by 1 PM

Stephen – BIRMINGHAM, West Midlands

Order # 204-8842201-2554739

[View or edit order](#)



Kitchen Sink Mixer Tap Single Lev...

Sold by Guoqing TangDE

Condition: New

Quantity: 1

£20⁹⁹

Total

£20.99

